

- Please read all instructions completely before starting any part of the installation.
- Each railing kit comes complete with all parts, hardware and installation guide to install one complete rail section (excluding posts.) Railing sections have been pre-cut to 6 ft. or 8 ft. lengths. Check to ensure that the kit is complete.
- AZEK Rail should be installed using the same good building principles used to install wood or composite railing and in accordance with the local building codes and the installation guidelines included below. AZEK Building Products Inc. claims no liability or responsibility for the improper installation of this product.
- AZEK Rail may not be suitable for every application and it is the sole responsibility of the installer to be sure that AZEK Rail is fit for the intended use. Since all installations are unique, it is also the installer's responsibility to determine specific requirements in regards to each Rail application.
- AZEK Building Products recommends that all designs be reviewed by a licensed architect, engineer or local building official before installation. If you have any questions or need further assistance, please call AZEK Customer Service at 877-ASK-AZEK (877-275-2935) or visit our website at www.azek.com.
- AZEK Railing is tested as a whole system and should be used that way. It is not intended to be used in conjunction with other railing systems or fasteners.
- **IMPORTANT:** Make sure the DRIVE TOOL/DRILL is configured or set to use the SCREW setting when driving and/or tightening all FASTENERS.
- **SAFETY:** Always wear goggles when handling, cutting, drilling and fastening materials.
- **NOTE:** Check local code requirements prior to installation.

**NOTE: 22.5° BRACKET INSTALLATION GUIDELINES to be used in conjunction with RAILING INSTALLATION GUIDELINES included in Rail kit for complete railing assembly and installation**

### Hardware included in 22.5° Angle Bracket Pack

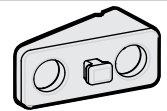

(2) Bracket Shims

## 1 Prepare for and Install Post Sleeves as indicated in RAILING INSTALLATION GUIDELINES included in Rail kit

## 2 Measure & Mark Top Retainer, Bottom Rail, & Handrail Ensuring Proper Hole Spacing...And Cut

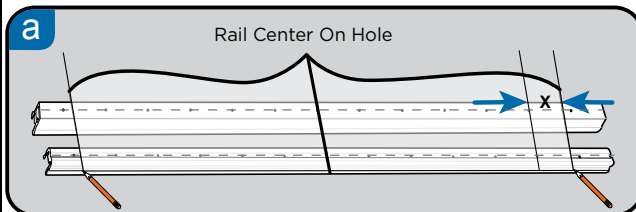

\* When measuring angled sections, measure length on center of Rails

**a** If X is greater than  $4 \frac{3}{8}$ " Baluster spacing will not meet code  
Shift Rail center from  
(a) Center On Hole to  
(b) Center Between Holes

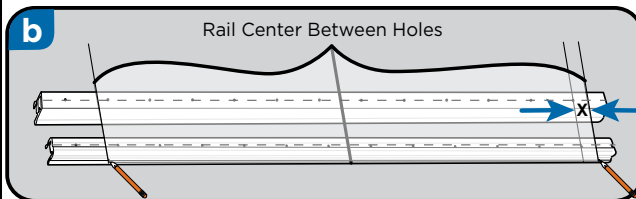

\* Ensure Posts are square and plumb.

\* Take measurements between bottom of Posts for more accurate rail length.

\* Leave Hand Rail  $\frac{1}{16}$ " longer than Top Retainer for a tight fit.

\* Most building codes require that a 4" sphere shall not pass through the rail at any point.

\* To comply with the 4" sphere rule, a 6 ft. rail section must be cut a minimum of  $\frac{7}{8}$ ".

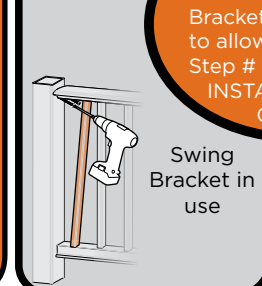
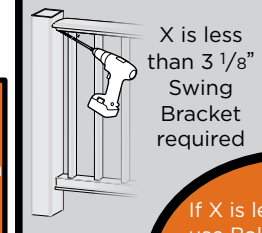
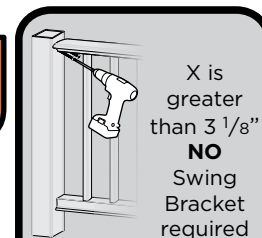
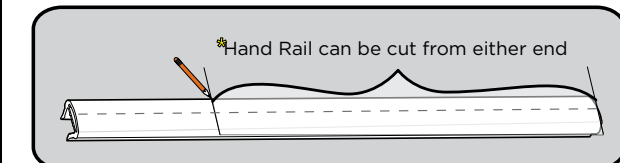

**b** If X is less than  $3 \frac{1}{8}$ " use Baluster Swing Brackets in Step to allow access in Step # 13 of RAILING INSTALLATION GUIDE

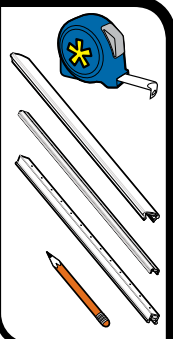

**3 Measure, Mark & Drill for Brackets**

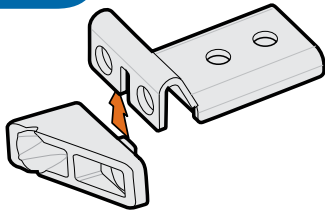

Install Shim on Top Retainer Bracket

Mark Bracket Assembly 1/16" from end of Top Retainer

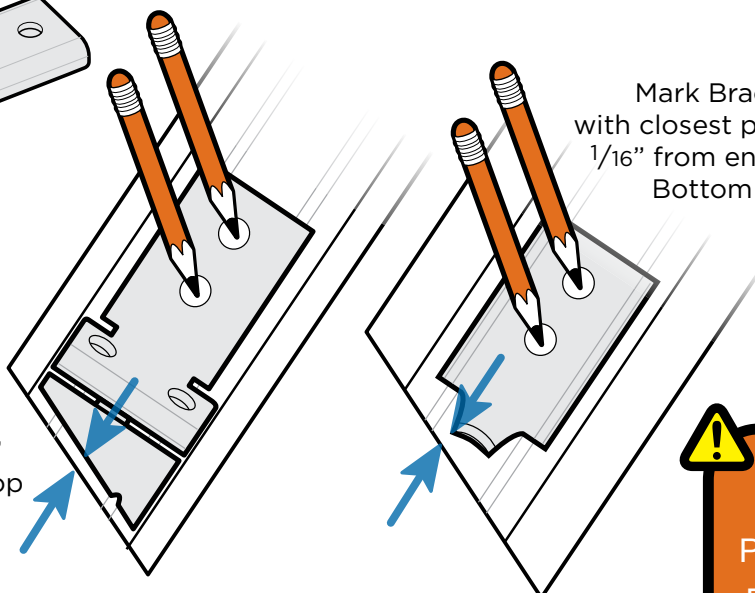

**Top Retainer**

**Bottom Rail**

Mark Bracket with closest point 1/16" from end of Bottom Rail

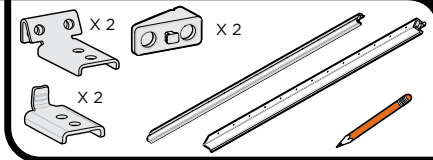

**!** When drilling holes for Brackets, do not drill through top surface of Bottom Rail

**!** **Now Pilot & Drill**  
Pilot with 1/8" Drill Bit  
Drill with 5/16" Drill Bit

**4 Install Brackets**

**Top Retainer**

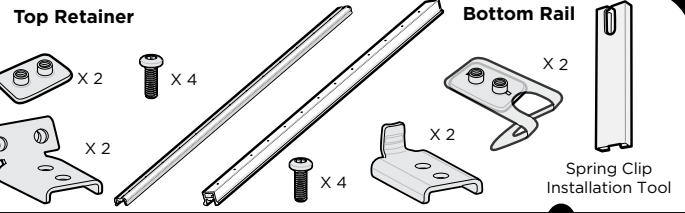
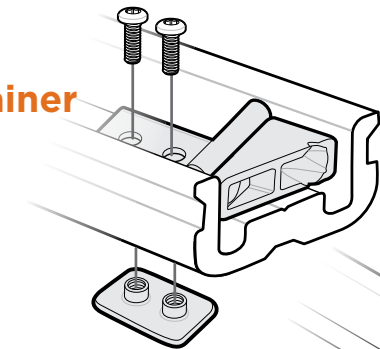

**!** **IMPORTANT**  
Make sure that the **DRIVE TOOL/DRILL** is configured or set to use the **SCREW** setting when driving and/or tightening all **FASTENERS**.

\* Remove installation tool before fully tightening Bracket screws

1 Close Spring Clip and insert it into Installation Tool  
2

**Bottom Rail**

**5 Continue installation process as indicated in RAILING INSTALLATION GUIDELINES included in Rail kit**